

# 1T/1U/1V

Square, round and half-ellipse shaped caps •  
for navigation unit • front panel sealing option



## DISTINCTIVE FEATURES

1T: 10.6 x 10.6; 1U: Ø10.6; 1V: 10.4 x 13.25 mm

h=14.9 mm

Rounded top surface

Front panel seal options to IP67 - 1U or IP65 - 1T & 1V

Can be combined for a navigation unit



SWITCH SPECIFICATIONS : see Multimec® 3 series.

### 3F+1T - TH

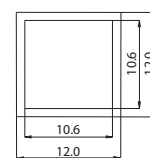
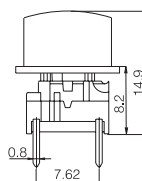
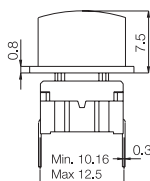

### 3F+1U - TH - W/LED

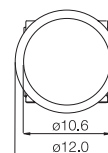
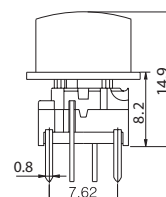
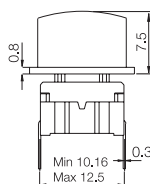

### 3F+1V - SMD

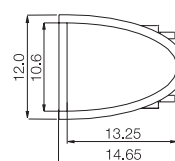
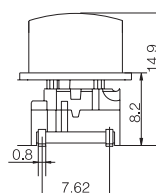
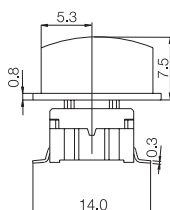

The company reserves the right to change specifications without notice. All tolerance if not otherwise specified ±0.2mm.

# 1T/1U/1V

Square, round and half-ellipse shaped caps •  
for navigation unit • front panel sealing option

## BUILD YOUR PART NUMBER

### ILLUMINATED

3F

SERIES

MOUNTING

TH9	through-hole
-----	--------------

LED

05	blue
20	green
40	yellow
65	white
80	red
2040	green/yellow
8020	red/green
8040	red/yellow

CAP

1T
1U
1V

COLOR

16	frosted white
----	---------------

### NON-ILLUMINATED

3F

SERIES

MOUNTING

TH9	through-hole
SH9	surface mount

CAP

1T
1U
1V

COLOR

00	blue
03	grey
08	red
09	black

**NOTICE** : Other versions : Please refer to [www.apem.com](http://www.apem.com) for information on the 5G series versions - 1TS/1US/1VS



## MOUNTING

- Panel cut-out :  
1T : min. 11.0 x 11.0 mm  
1U : min. Ø11.0 mm  
1V : min. 11.0 x 13.65 mm
- Switch spacing AxB : min. 12.7 x 12.7 mm

DISTANCE BETWEEN PCB  
AND FRONT PANEL  
IN CASE OF SEALING

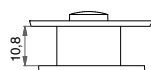

## MATERIALS

- Cap :  
- solid color : ABS UL94HB  
- illuminated : polycarbonate UL94HB



## STANDARD LEGENDS

STANDARD LEGENDS									
LEGEND	1D09_	1F096R_	1ZB09D_ 1ZB16DLMH_	1ZC_	1Z_ 1ZW_	10A_	10C_	10R_ & 10RF_ 10RM16_	10Q_ 10QM16_
0	000	000							
1	001	001							
2	002	002							
3	003	003							
4	004	004							
5	005	005							
6	006	006							
7	007	007							
8	008	008							
9	009	009							
#	107	107							
*	019	019							
←	033								
→	133								
↑	034								
↓	134								
↶	135	135							
+						054		054	054
-						059		059	059
▲			136		136	136			
⏻	123	123		123*	123		123	123	123
ON/OFF								017	017
STOP								018	018
START								031	031
RESET				038				038	038
CANCEL								048	048
ENTER								105	105
ESC				051					
ON						116			
OFF						117			
OK				118*	118		118	118	118
SET				119					
MENU				120					
FUNC				121					
HOME				122					

### STANDARD OPTIONS

- 1D: pad printed
- 1F: reverse printed
- 1ZB: pad printed / laser marked
- 1ZC: pad printed \*reverse printed \*laser marked
- 1Z & 1ZW: pad printed / laser marked

- 10A: pad printed / laser marked
- 10C: pad printed / laser marked
- 10RM & 10QM: metal symbol
- 10R(F) & 10Q: pad printed / reverse printed

# Legends

Available for Multimec caps



## HOW TO ORDER

### POSITIONING OF LEGENDS ON ROCKER-ACTION CAPS

When ordering legends for caps with hinge-type cap retention system, it is important to note the position of the cap. An extra letter (U, D, R or L) needs to be added to the part number to refer to the position of the hinges in relation to the legend. See samples:

Rocker-action caps without a lens: 1A, 1B, 1M, 1ZA and 1ZB

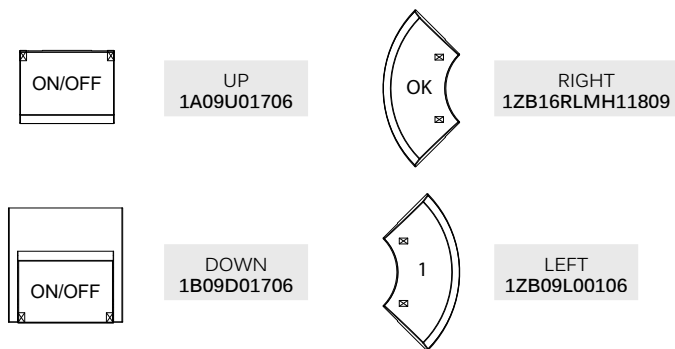

### STANDARD AND CUSTOM LEGENDS

- Standard are only certain legends on certain caps. See the table on the previous page.
- All standard pad-printed legends are white on black caps.
- All standard reverse-printed and laser marked legends are black on frosted white cap.

### LEGEND ILLUMINATION

- **Option 1 - laser marked:** In case of laser marked legends an "LM" is added after the cap colour, before the legend code. We recommend using hard paint (additional "H") for increased lifetime of the paint. E.g. 1ZB16DLMH13609
- **Option 2 - reverse printed:** In case of reverse printed caps an "R" is added after the cap colour, before the legend code. Especially relevant when standard legends have both negative and positive print options. E.g. 1FS096R00009
- **Option 3 - metal symbol:** Only available for 10RM and 10QM (therefore the "M"). E.g. 10RM16059

### ORIENTATION OF THE SWITCH

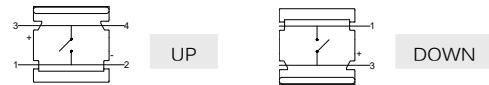

### STANDARD LEGENDS

CAP	CAP COLOR	DIRECTION*	TYPE*	LEGEND	LEGEND COLOR*
1B	00 Blue	D Down	LM Laser marked on soft paint	001 1	00 Blue
1DS	02 Green	U Up	LMH Laser marked on hard paint	002 2	02 Green
...	03 Grey	R Right	R Reverse printed	003 3	03 Grey
	04 Yellow	L Left		... etc	04 Yellow
	06 White	*Only for hinge-type caps			06 White
	08 Red	*In case of illumination			08 Red
	09 Black				09 Black
	16 Frosted white				... Etc
	...				

\*In case of reverse printed and laser marked legends the colour of the paint





















**Notice:** The size of the legends listed may not correspond to the actual size.

If you decide to use one of the standard legends without any adjustments (without a new cliché or programming) on another cap than designated in the table, then there is no cliché or programming cost, for this to apply the cap has to be black and the print white.

For further information on legends please contact your local distributor or MEC.

# Solid colors

Available for Multimec caps

Colour / RAL Code		Blue / 5012	green / 6018	Grey / 7004	Yellow / 1023	White / 9010	Red / 3000	Black / 9004	Ultra blue / 5002	Mint green / 6029	Tele grey / 7046	Melon / 1028	Signal white / 9003	Noble red / 3002	Dusty blue / 5014	Aqua blue / 5021	Metal dark blue / No ral code	Metal light grey / No ral code	Metal dark grey / No ral code	Metal bordeaux / No ral code	
CAP	CODE	00	02	03	04	06	08	09	30	32	33	34	36	38	40	42	50	53	57	58	
1A		•	•	•	•	•	•	•													
1B		•	•	•	•	•	•	•													
1D		•	•	•	•	•	•	•	•	•	•	•		•	•	•	•	•	•	•	•
1E/1F				•				•													
1GA/1GC								•													
1H				•				•													
1K		•	•	•	•	•	•	•													
1M			•	•			•	•													
1N				•				•													
1P		•	•	•	•	•	•	•													
1Q		•		•				•													
1R				•																	
1S		•	•	•	•	•	•	•													
1T/1U/1V		•		•			•	•													
1WA/ 1WD				•				•													
1X				•		•		•													
1ZA				•		•		•	•						•	•	•	•	•	•	•
1ZB				•		•		•	•						•	•	•	•	•	•	•
1ZC				•		•	•	•	•						•	•	•	•	•	•	•
10A				•			•	•													
AQC								•													

The RAL Codes mentioned are the codes nearest to the solid colors in the multimec® range.

\*3E actuators and Varimec use different materials and therefore have a different color code and are not represented in this table

# Multimec® 3F

High performance tactile switches •  
robust



## DISTINCTIVE FEATURES

10 x 10 mm; h=10.4 mm

Illuminated RAS with 3F series

3F series has a slip-on cap retention system - great for custom caps



## ENVIRONMENTAL SPECIFICATIONS

- Sealing : IP67 according to IEC 60529
- Working and storage temperature :
  - non-illuminated : -40 °C/+160 °C
  - illuminated : -30 °C/+85 °C
- Soldering :
  - through hole : IEC 68-2-20 8
  - surface mount : JEDEC J-STD-020E



## ELECTRICAL SPECIFICATIONS

- Recommended load :
  - Gold contacts : 0.5  $\mu$ -50 mA 24 VDC
  - Silver contacts : 0.5-50 mA 24 VDC
- Contact resistance : <30 m $\Omega$  - typically 10 m $\Omega$
- Insulation resistance : >10 M $\Omega$
- Contact bounce : <2 mS - typically 0.5 mS



## MECHANICAL SPECIFICATIONS

- Standard actuation force 3.5 N
- Max. actuation force : 100 N for 10 sec
- Travel : 1 mm
- Lifetime : >10,000,000 cycles

The company reserves the right to change specifications without notice.



## MATERIALS

- Housing : PPS UL94V0
- Actuator : PPS UL94V0
- Sealing : Silicone rubber
- Contacts spring : Stainless steel
  - Silver : +3  $\mu$ Ag
  - Gold : +1  $\mu$ Au
- Fixed contacts :
  - Silver : SnCu + 2  $\mu$ NI + 3  $\mu$ Ag
  - Gold : SnCu + 2  $\mu$ NI + 1  $\mu$ Au
- Terminals : SnCu + 2  $\mu$ NI + 3  $\mu$ Sn100

All tolerance if not otherwise specified  $\pm$ 0.2 mm.

# Multimec® 3F

High performance tactile switches •  
robust

## 3F - SMD

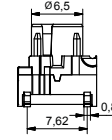
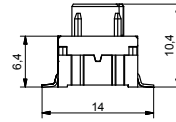
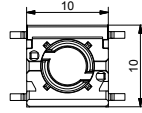

## 3F - TH

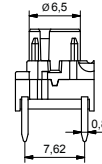
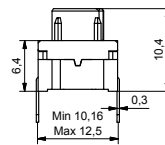
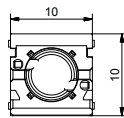

## 3F - TH W/LED

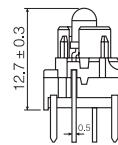
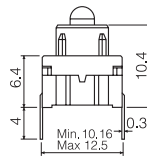
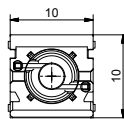

## 3F - RAS

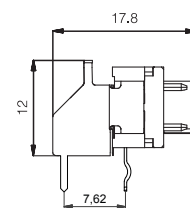
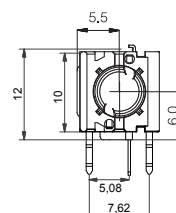
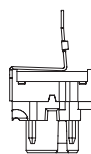

High performance tactile switches • robust

## 3F - RAS W/LED

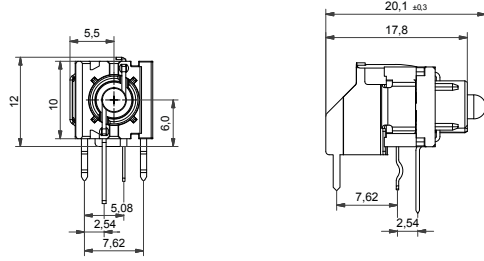
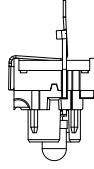

## PCB LAYOUT & CIRCUIT DIAGRAM

TH Non-ill.

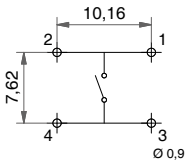

SMD non-ill.

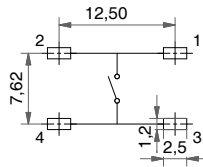

TH illuminated

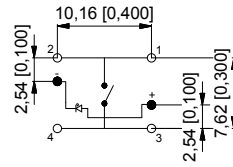

TH bi-color illuminated

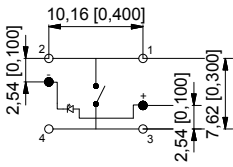

RAS

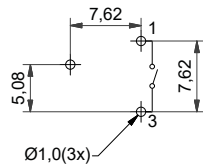

RAS illuminated

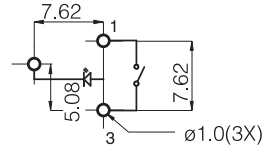



# Multimec® 3F

High performance tactile switches •  
robust

## BUILD YOUR PART NUMBER

### ILLUMINATED

3F

SERIES

MOUNTING

<b>TH9</b>	through-hole
------------	--------------

LED

<b>05</b>	blue
<b>20</b>	green
<b>40</b>	yellow
<b>65</b>	white
<b>80</b>	red
<b>2040</b>	green/yellow
<b>8020</b>	red/green
<b>8040</b>	red/yellow
<b>24</b>	high intensity green
<b>46</b>	high intensity yellow
<b>87</b>	high intensity red

OPTIONAL

<b>Q</b>	quiet contact
<b>G</b>	gold contacts
<b>RAS</b>	right angle

### NON-ILLUMINATED

3F

SERIES

MOUNTING

<b>TH9</b>	through-hole
<b>SH9</b>	surface mount

OPTIONAL

<b>Q</b>	quiet contact
<b>RAS</b>	right angle (with TH only)
<b>R</b>	tape & reel
<b>G</b>	gold contacts

## ABOUT THIS SERIES

 **Caps and accessories** : for the full range of accessories for Multimec 3F please see the website.

# Multimec® 3F

High performance tactile switches • robust



## TAPE & REEL

Tape and reel is available for the parts listed and has the following specifications

- Reel diameter: Ø330 mm
- Tape width: 24 mm
- Pitch: See list
- Tape and reel material : antistatic or better
- Quantity per reel : see list

PART NO.	ORDERING CODE	PITCH	QUANTITY PER REEL
3FSH9	3FSH9R	20	250



## OPERATING FORCE

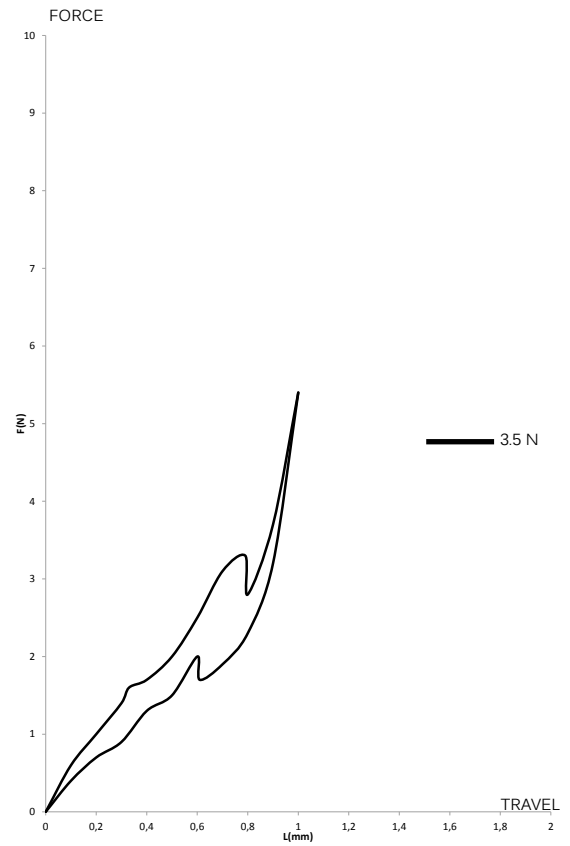

## MOUNTING

MOUNTING TOOLS FOR MULTIMEC® THROUGH-HOLE SWITCHES

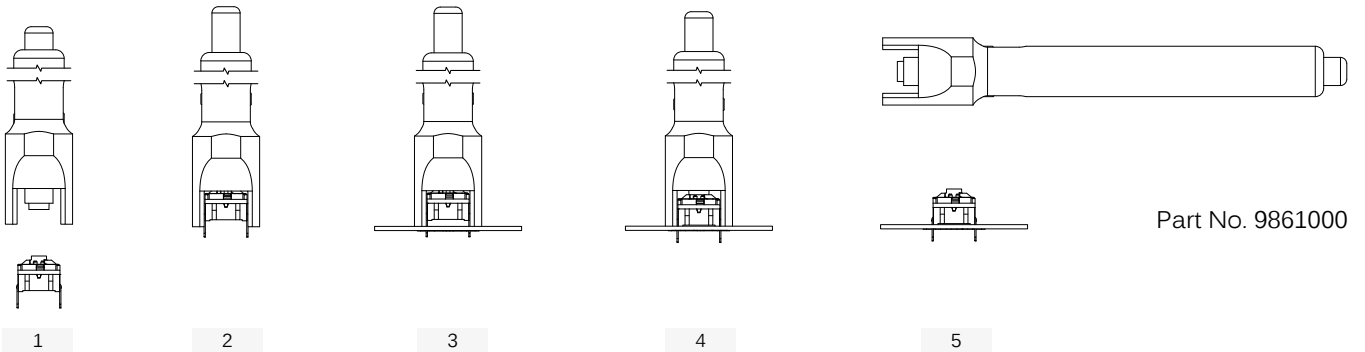

# Multimec® 3F

High performance tactile switches • robust



## MOUNTING (CONTINUED)

### SPACE REQUIREMENT - MATRIX MOUNTING

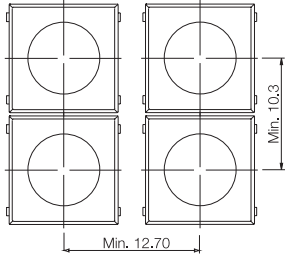

Through-hole (TH)

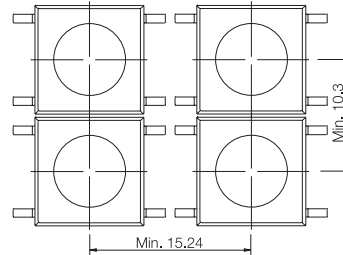

Surface mount (SMD)

### SPACE REQUIREMENT - SWITCH/CAP

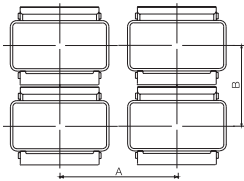

Switch spacing

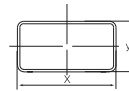

Cap dimensions

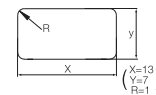

Panel cut-out

### MULTIMEC® SPACING EXAMPLES

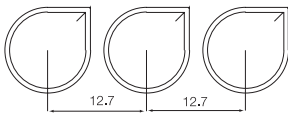

1N+1N+1N

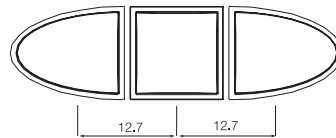

1V+1T+1V

CAP SERIES	RECOMMENDED MIN. SWITCH SPACING AxB	NOMINAL CAP DIMENSION WxH	RECOMMENDED MIN. PANEL CUT-CUT
1D/1E/1F	12.7x12.7	Ø9.6	Ø10
1GA	12.7x11.14	Ø11	Ø11.4
1GC	15.14x15.14	Ø15	Ø15.4
1K/1KB/1KC	15.24x15.24	14.3x14.3	14.7x14.7
1N	12.7x12.7	Ø9.8/ □4.9	Ø10.2/□5.1
1P/ 1Q/1R	15.24x10.16	6.5x12.5	7x13, R max. 1.0
1S	12.7x12.7	Ø6.5	Ø7
1T	12.7x12.7	10.6x10.6	11x11
1U	12.7x12.7	Ø10.6	Ø11.0
1V	12.7x12.7	10.6x13.25	11.0x13.65
1WA	12.7x10.3	12.5x6.5	12.9x6.9
1WD	15.34x10.3	15.2x8.0	15.6x8.4
1X	12.7x12.7	9.4x7.4	9.8x7.9
1ZC	14.44x14.44	Ø14.3	Ø14.7



## LED COMPONENT SPECIFICATIONS

LED COMPONENT SPECIFICATIONS												
Color		B	G	Y	W	R	G/Y	R/G	R/Y	G	Y	R
Color Codes		05	20	40	65	80	2040	8020	8040	24	46	87
ABSOLUTE MAXIMUM RATINGS (Ta=25°C)												
Power	mW	135	70	60	120	60	120	100	120	60	60	120
Current forward	mA	30	20	20	25	20	25	30	25	25	25	50
Forward peak current	mA	70	60**	60**	100	60**	150	120	150	60	60	200
Voltage reverse	V	5	3	3	5	3	5	5	5	5	5	5
Operating temperature	°C	-20/+80	-40/+85		-40/+85	-25/+85	-40/+85	-55/+100	-40/+85	-40/+85	-40/+85	-40/+85
Storage temperature	°C	-30/+100	-40/+85		-40/+100		-40/+85	-55/+100	-40/+85	-40/+85	-40/+100	-40/+100
Soldering temperature	°C	260 for max 5 sec					260 for max 2 sec			300 for max 3 sec	260 for max 5 sec	
ELECTRICAL-OPTICAL CHARACTERISTICS (Ta=25°C)												
Voltage forward	Typ. V	3.8	2.1	2.1	3.8	2.0	2.1	2.0	2.1	2.0*	2.0	2.0***
	Max. V	4.5	3.0	3.0	4.3	3.0	2.8	2.6	2.8	2.4*	2.4	2.4***
Current reverse (VR=5V)	µA		10	10	50	10	2	2	2	10	10	10
Wave length	nm	466	563	585	NA	650		630/565	625/590	570	589	624/632
Spread	Δnm	45	40	40	NA	40	35	35	35	10	NA	20
Spread angle	degree	60	45	45	25	45	60	200	60	100	40	40
Luminous Intensity	Min. mcd	25	9.0	5.6	630	5.6	8	2.2	8	70****	630	400****
	Typ. mcd	60	25	16	1000	16	25	4.8	25	20****	1250	800****
Orientation	The longer pin is the anode, the shorter is the cathode. For bi-color LEDs the anode for the first color (ex. 8020) is the longer pin.											

\*/F=20mA, \*\*Pulse width 1ms Duty cycle 1:5, \*\*\*/F=50mA, \*\*\*\*Luminous Flux mlm

# Multimec® 3F

High performance tactile switches • robust



## USAGE GUIDELINES

### HOW TO GET THE BEST RESULTS WITH MEC SWITCHES ?

These guidelines are offered to users of MEC Switches as an aid to ensure successful and reliable switch operation. Please see the technical specifications for details on operating and storage temperatures and soldering guidelines to make sure you select the best switch for your application. When wave soldering is taking place, MEC strongly recommend that the temperature profile is analyzed and compared with the temperature rating of the switch. It is also important to monitor the accumulated heat buildup from both the pre-heat zones and the solder zone.

Most standard accessories for multimec® 3 series switches are made from ABS plastic with a maximum operating temperature of 65 °C. It is strongly recommended that accessories are mounted after soldering of the switch. If this is not possible care must be taken not to overheat the accessories during the soldering process. The 1S and 1GA/1GC caps are, however, made of high temperature materials and will meet the same temperature specifications as the switches. For accessories made from other plastic materials please see multimec® and unimec™ technical specifications.

LEDs have their own temperature specifications. When fitted in a 3F switch the LED will determine the max. operating temperature, i.e. 3FTH924 has an upper temperature limit of 85 °C!

### MOUNTING AND DISMOUNTING

If switches are to be mounted in rows it is essential that the recommendations regarding spacing are followed. PC board thickness should be 1.4 ±0.2 mm and terminal hole diameter should be 0.9 mm.

All multimec® caps and bezels are easily slid onto the switch modules and can be changed at a later time with the exception of the 3E caps. Once these caps are installed they are not designed to be removed. To do so may cause damage to the switch and the PC board if not done very carefully.

Care must be taken when inserting the 3FT switch and LED assembly into the PC board. Do not press direct on the LED. This will force the LED down into the actuator and risks to cause the switch contacts to remain in the closed position. To correct the fault, the LED must be raised slightly and centered in the actuator to assure unrestricted movement of the actuator.

A mounting tool is available for through hole multimec® 3 series switches.

### SOLDERING AND CLEANING MULTIMEC® 3 SERIES

Multimec® 3 series switches are fully sealed to IP67 specifications to prevent solder flux and aqueous based cleaning solutions from entering the switch and contaminating the

contacts. The switches can be placed on the PC board with other components and wave soldered. Multimec® 3 series offers a high level of sealing, however, with aqueous solvent solutions care must be taken to avoid the worst case situation with water jets, complete immersion into a liquid with a temperature below the board or surface tension reducing additives.

Recommended cleaning methods are demineralized water. Any surface tension reducing agents, such as soap, must not be used as they risk causing a potential leakage of the switch.

### SOLDERING - THROUGH HOLE VERSIONS

**Hand soldering:** max. 350 °C for max. 3 sec

**Wave soldering:** heat built up in the switch during pre-heating and soldering must not exceed the maximum operating temperature of the switch. Peak temperature must not exceed 260 °C, and soldering time is max 10 sec. (IEC 60068-2-20 8)

### SOLDERING - SURFACE MOUNT VERSIONS

For all methods - infrared, convection and vapor phase. The upper limit 240 °C/40 sec must be observed. The soldering temperature profile must have moderate temperature gradients. (JEDEC J-STD-020E)

### ROHS COMPLIANCE

As of 1 July 2006 MEC has completed the conversion to RoHS compliance. For more info please see our homepage [www.apem.com](http://www.apem.com)

### TEMPERATURE LIMITS:

Switch	160 °C
LEDs	80/85/100 °C
Accessories	65/85/160 °C

### PACKAGING

Multimec® 3 series switches are packed in rigid tubes of 50 pieces each.

A box contains 1.000 pcs.

The surface mount versions of multimec® 3 series switches with a height up to 12.5 mm can also be delivered on tape/reel.

Each reel contains 250/500 pcs.